

Model 1205CXA

Coaxial
Metallic Time Domain Reflectometer

Operator's Manual



Radiodetection

Riser Bond

January 2007

Thank you for purchasing Riser-Bond Instruments' Model 1205CXA Metallic Time Domain Reflectometer. Our goal is to provide you with a high quality troubleshooting tool which is both powerful and easy to use. We all share a commitment to quality and excellence and will do our best to continue to provide you with test equipment to meet your needs. Please read the operator's manual thoroughly to ensure the best results from your TDR. As always, Riser-Bond Instruments welcomes your comments and suggestions.

Radiodetection
154 Portland Road
Bridgton
ME 04009
USA

Tel: (207) 647-9495
Toll Free: (877) 247-3797
Fax: (207) 647-9496
E-mail: bridgton@radiodetection.spx.com

Radiodetection Ltd.
Western Drive
Bristol
BS14 0AF
United Kingdom

Tel: +44 (0) 117 976 7776
Fax: +44 (0) 117 976 7775
E-mail: sales.uk@radiodetection.spx.com

TABLE OF CONTENTS

SECTION 1: GENERAL INFORMATION.....	2	SECTION 4: APPLICATION NOTES.....	23
1.1 Safety Information.....	2	4.1 TDR Tap Plate Connector.....	23
1.2 Introduction	3	4.2 Missing Signals, Corroded Splices, and Unidentified Cables.....	24
1.3 General Features.....	3	4.3 Detecting Intermittent Faults.....	24
SECTION 2: OPERATING PROCEDURES.....	4	4.4 Measuring and Documenting.....	25
2.1 Theory of Operation.....	4	4.5 Detecting Theft of Service.....	26
2.2 Front Panel Description	5	SECTION 5: WAVEFORM EXAMPLES.....	28
2.3 Instrument Operation.....	10	SECTION 6: MAINTENANCE.....	36
SECTION 3: TDR FUNDAMENTALS.....	19	SECTION 7: SPECIFICATIONS.....	37
3.1 First-time Start Up.....	19	APPENDIX A - Serial I/O Printer Port.....	39
3.2 Cable Connection.....	19	APPENDIX B - VOP Table.....	39
3.3 Cable Check.....	19	WARRANTY	
3.4 Cable Impedance.....	19		
3.5 Velocity of Propagation (VOP).....	19		
3.6 Pulse Widths.....	21		
3.7 Return Loss/ Fault Severity.....	22		

SECTION 1: GENERAL INFORMATION

1.1 Safety Information

Symbols:



Caution: Refer to accompanying documents.

Warning Any **Warning** sign identifies a procedure or process, which if not correctly followed, may result in personal injury.

Caution Any **Caution** sign identifies a procedure or process, which if not correctly followed, may result in equipment damage or loss of data.

Warnings

Before using, review all safety precautions. Note and observe all warning and caution statements on the equipment and in the documentation.

Do not operate this instrument near flammable gases or fumes.

Do not modify any part or accessory of this instrument. If the unit is damaged, do not use. Also, secure the product from use by others.

To avoid electric shock, do not remove covers or any parts of the enclosure.

If the instrument or any associated accessory is used in any manner not detailed by the accompanying documentation, the safety of the operator may be compromised.

Caution: As with most electronic equipment, care should be taken not to expose the equipment to extreme temperatures. To insure that your Model 1205CXA will be ready to use, store the instrument indoors during extreme hot or cold temperatures. If the instrument is stored overnight in a service vehicle, be certain the instrument is brought to specified operating temperatures before using.

1.2 Introduction

The Model 1205CXA is a multipurpose metallic time domain reflectometer (TDR), cable fault locator designed to quickly and easily locate cable faults in metallic cable. The Model 1205CXA combines the latest in technology and user-friendly operation, creating the most versatile and accurate TDR available.

Using time domain reflectometry, or cable radar, the Model 1205CXA transmits a signal down the cable. Impedance discontinuities along the length of the cable reflect some or all of the signal energy back to the instrument. These reflections are measured and displayed as both a waveform and a numeric distance to the fault.

The Model 1205CXA will test all types of metallic paired cables for opens, shorts, impedance discontinuities, and many other cabling problems.

1.3 General Features

Locates cable and connector faults in all types of paired metallic cables.

Tests both twisted pair and coaxial cables.

Sensitive sub-nanosecond pulse width locates small faults that can plague high bandwidth systems or cause digital interruption.

Rugged packaging for testing in all types of weather conditions.

RANGE-PLUS offers pre-set ranges for quick testing.

Automatic and manual cursor placement functions.

Exclusive SUPER-STORE waveform storage.

Unique dual independent cursors.

Compact, lightweight, portable.

RS-232 Port.

SECTION 2: OPERATING PROCEDURES

2.1 Theory of Operation

A Time Domain Reflectometer (TDR) works on the same basic principle as radar. Pulses of energy are transmitted down the cable under test. If the cable has a constant impedance and is properly terminated, all of the energy will be absorbed.

If the pulse reaches an impedance discontinuity, part or all of the pulse energy is reflected back to the instrument. If the cable is an open circuit, the reflected pulse will be in-phase (upward reflection) with the output pulse. If the cable is a short circuit, the reflected pulse will be out-of-phase (downward reflection) with the output pulse.

In either case, a substantial amount of energy will be reflected. If it were possible to have a cable with no loss, all of the signal energy would be reflected. The incident and the reflected signals would look identical.

Reflections from an impedance higher than the characteristic impedance of the cable are in-phase, or upward. Reflections from an impedance lower than the characteristic impedance of the cable are out-of-phase, or downward.

Inductive faults cause the TDR to display an impedance higher than the characteristic impedance of the cable being tested. Capacitive faults cause the TDR to display an impedance lower than the characteristic impedance of the cable.

The Model 1205CXA displays the cable under test as a digitized waveform with a numeric distance readout on the Liquid Crystal Display.

The digitized waveform enables the operator to view the signature of the cable in great detail. An impedance mismatch (opens, shorts or faults of less severity) can be identified and distances to the faults determined.

2.2 Front Panel Description

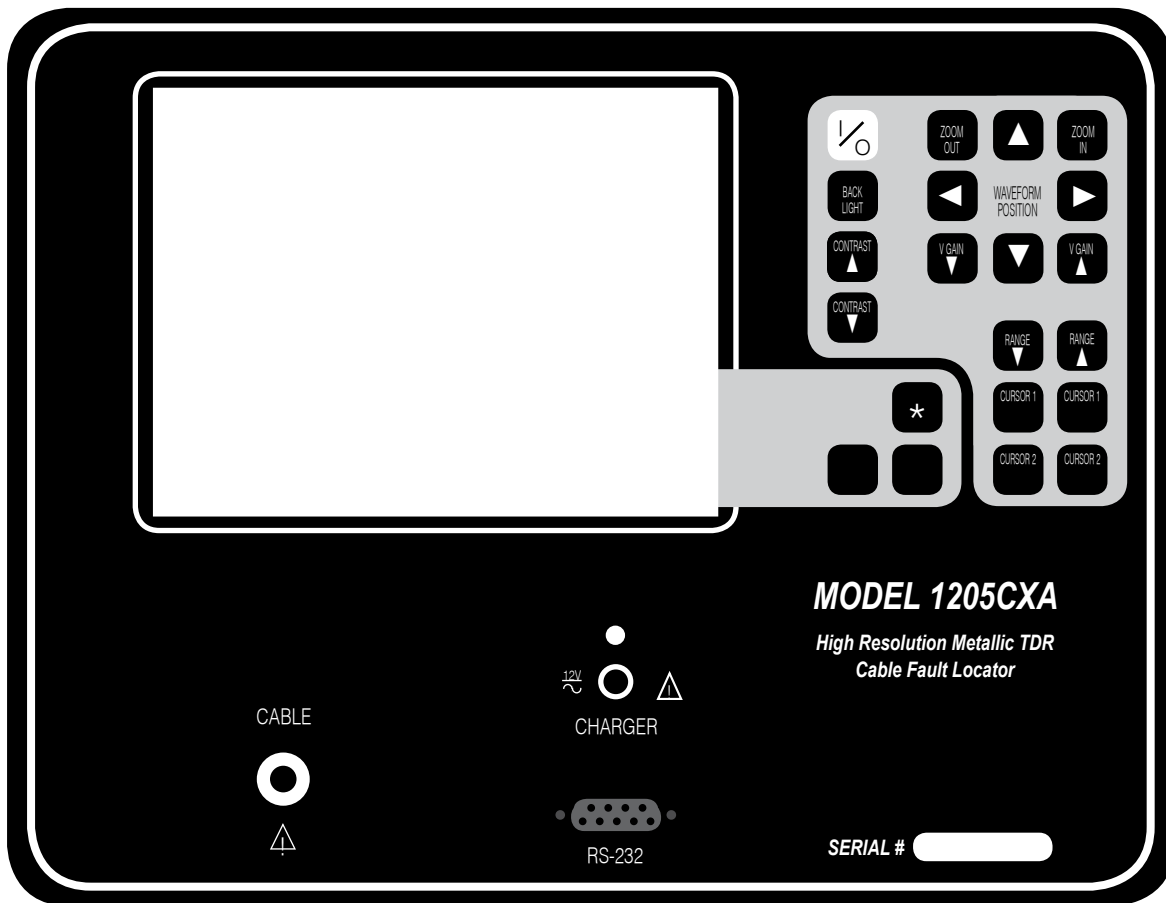

Keypad

I/O Use the I/O key to turn the instrument on and off.

Backlight Use the backlight key to turn the CFL backlight on or off.

Contrast Use the two arrow keys to change the contrast of the LCD.

Zoom In, Zoom Out Use the two zoom keys to zoom in or out on an area of interest on the waveform display.

Waveform Position Use the four arrow keys to move the position of the waveform(s) left, right, up, and down.

V Gain Use the two arrow keys to decrease and increase the vertical waveform amplitude or gain.

Range Use the two range keys to increase and decrease the cable distance displayed on screen. Pulse width and vertical gain are automatically adjusted for each range.

Cursors The 1st and 2nd cursor keys move the cursors along the waveform. Use the 2nd cursor arrows to move the second cursor to the point of interest on the waveform. Cursors should be set on the leading edges of the reflection.

* A menu will pop-up when the asterisk key is pressed. The unlabeled icon keys control a selection cursor for choosing the desired instrument control. Once the control is selected, pressing the asterisk key will close the pop-up menu and activate the control.

When a control is activated, the icon keys will control the function and on-screen icons will graphically represent how the icon keys affect the control. The icon will change depending on the type of action in the particular control.

Display

The display is a 320 x 240 dot-matrix, high contrast, SUPERTWIST Liquid Crystal Display (LCD) with cold cathode fluorescent lamp (CFL) backlighting. The top two-thirds of the display contains the waveform and cursors. Instrument setting and measurements are located on the bottom of the display.

Information areas on the Liquid Crystal Display (LCD) are:

A. Message Center The message center displays various information about the status of the instrument. Additional messages are displayed when utilizing the standard and optional waveform storage functions.

B. Pulse Width Model 1205CXA has selectable pulse widths for testing various lengths of cable.

C. Vertical Gain Displays the level of vertical amplitude or gain applied to the waveform.

D. VOP or V/2 The programmed velocity of propagation is displayed as a percentage of the speed of light from 30% to 99%.

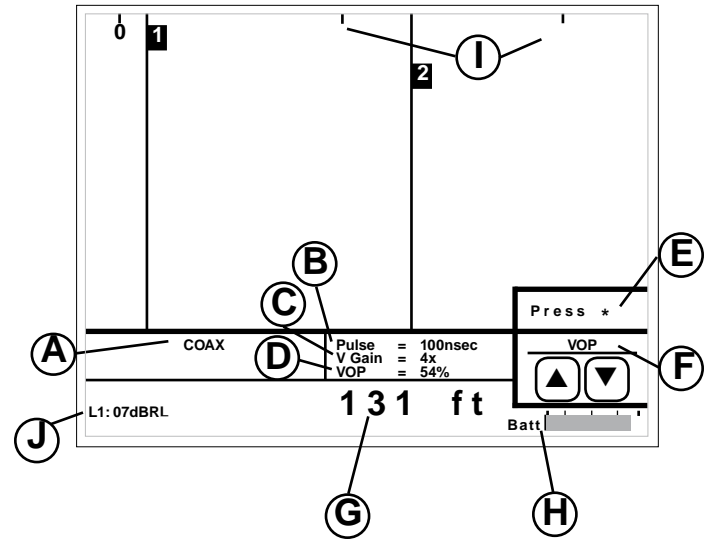

E. Menu Pop-up menu for selecting instrument controls.

F. Selected Menu Items Displays the currently active menu selection, which is controlled by the icon keys. The on-screen icons graphically represent how the keys affect the control.

G. Distance Between Cursors The Model 1205CXA automatically calculates and displays the distance between the 1st and 2nd cursors. Each time the cursor placement is changed or the VOP is adjusted, the DISTANCE BETWEEN CURSORS reading will automatically update.

H. Battery Level Indicator A horizontal bar graph indicates the battery level. When the battery level reaches the one-quarter full scale mark, the low battery message is activated.

I. Distance Markers These tick marks are displayed along the top of the screen and can be in feet or meters format. These marks enable the operator to view the distance along the cable being tested.

J. Fault Severity The Model 1205CXA automatically calculates the signal return loss (dBRL).

Pop-up menu

Store Use the icon keys to select an available storage location and press the * key to store.

Recall Use the icon keys to select a storage location and press the * to recall to display.

Pulse Use the two icon keys for decreasing and increasing the pulse width.

Cable Use the two icon keys to select the cable type under test. VOP will automatically be set for the cable type selected.

VOP or **V/2** (depending on the velocity format setting chosen in the setup menu) Use the two icon keys for decreasing and increasing the velocity of propagation.

Filter Use the two icon keys for cycling through the available software filters.

Setup Use the * key to display the setup options menu.

Print Use the * key to print the on-screen waveform to a serial printer for documentation.

Mode Use the two icon keys for cycling through the available display modes for single, dual, or difference waveform display modes.

Overlay Use the two icon keys to adjust the trace separation in dual waveform display modes. This control is only available when two waveforms are displayed.

Tagging Use the * and icon keys to edit the alpha numeric label associated with a stored waveform.

Search Use the * key to perform an auto-search of the cable to find major faults or the end of the cable.

Press * to select.	
Store	Print
Recall	Mode
Pulse	Overlay
Cable	Tagging
VOP	Search
Filter	
Setup	

2.3 Instrument Operation

Proper operation and precise distance readings will be insured if you remember the following procedures and choose the mode of operation to best suit your cable testing conditions:

1. Establish a quality cable connection. It is best if the cable is adapted to connect directly to the instrument front panel. Use adapters and connectors with the same impedance as the cable under test.
2. Enter the correct VOP of the cable under test. (See Section 3.5)
3. Start the test in the shortest range or pulse width.

2.3.1 Range Control

RANGE-PLUS operation will step through and display a preset distance of cable. A range consists of a specific pulse width, gain setting, and distance of cable. The transmitted pulse is on the left side of the screen and the cable span is shown to the right. The exact length of cable on the screen for each range will be relative to the VOP being used. When using range, you still have complete manual control and can change the pulse width, zoom-level and other key functions as needed.

With the distance format set in feet mode and a 83% VOP, the ranges are 10, 20, 50, 100, 200, 500, 1k, 2k, 5k, 10k, 20k feet.

Characteristics of RANGE-PLUS operation:

1. To switch to the next range, press the RANGE up and down arrows. The distance graduations will change as the range is changed.
2. Cursor 2 can be moved while in the RANGE mode. As the ranges are changed, cursor 2 will remain at the same position as the previous range.
3. Cursor 1 can also be adjusted; however, it will be placed back at the "0" distance marker whenever a new range is selected.

2.3.2 Distance Between Cursors

When a test is initiated, the two independent cursors are used to measure the distance to a fault or to the end of the cable. The cursors are interchangeable; but, to reduce confusion, use the 1st CURSOR to mark the point you are measuring from and the 2nd CURSOR to mark the point you are measuring to. The cursors will retain their accuracy and resolution regardless of distance or horizontal zoom settings.

Model 1205CXA's unique dual independent cursors feature allows you to place cursors at, and measure to (or between) ANY TWO POINTS on the waveform. The distance displayed will automatically adjust with the movement of the cursors.

DISTANCE BETWEEN CURSORS is automatically calculated and displayed. Distance is determined from the cursor placement on the waveform. Therefore, the accuracy of the cursor placement is crucial to accurate readings. For greatest accuracy, place the 1st cursor to the "0" distance marker and the 2nd cursor at the leading edge of the reflected pulse.

To set the cursors, zoom in on the point of interest using HORIZONTAL ZOOM. Set the first cursor by using the 1st cursor left and right arrows to the "0" distance marker on the waveform. To set the second cursor, use the 2nd cursor left and right arrows to move the second cursor to any point of interest. For a more accurate distance reading, zoom in on the reflected pulse for better detail and adjust cursor placement manually.

The distance between the cursors is displayed on the LCD. Remember that the distance measurement is not from the transmitted pulse, but from the first cursor to the second cursor. Accuracy of the distance reading is dependent on the placement of the cursors and an accurate VOP.

2.3.3 Display Modes

Live Display Mode Loops:

The Display mode loop alternates between Coax and IFD (Intermittent Fault Detection) mode.

→ **Line**
└ **IFD**

Displays active test port.
Displays IFD waveform.

Recalled Display Mode Loops:

When a waveform has been recalled from memory, the Mode control will cycle through display modes involving the coaxial test port and the recalled waveform. The loop described below applies to the test port.

→ **Line & Stored**
└ **Line-Stored**
└ **Stored**
└ **Line***

Displays Live and Stored waveforms simultaneously.
Displays difference between Live and Stored waveform.
Displays Stored waveform only
Displays Coax (active test port) waveform

* To exit the recalled waveform loop, enter the Live mode and wait five seconds.

2.3.4 Intermittent Fault Detection (IFD) Mode

The IFD mode detects and displays intermittent faults, whether they are opens or shorts. Some TDRs have a similar feature; however, if the waveform is repositioned, the intermittent fault function is interrupted and the process must be started over. The Model 1205CXA's IFD mode retains the waveform trace. The waveform can be adjusted, repositioned, zoomed in and out, and the cursors moved, without affecting the IFD function. The Model 1205CXA will monitor the cable, waiting for an intermittent fault to occur.

Upon entering the intermittent fault mode:

The LCD's waveform area displays and saves the maximum and minimum reflections of the waveform trace. The auto-off 10 minute timer is disabled so the instrument does not turn off in the middle of the test.

The IFD waveform area stores waveform changes. If an open or short occurs, the instrument will keep the fault trace displayed against the live waveform. This function allows the user to find intermittent problems.

The operator can adjust the waveform with the horizontal position controls, increase or decrease the vertical gain, zoom in or out, and move the cursors. When zooming

during the IFD mode, the instrument may need to pause slightly to fill in additional waveform data.

During the IFD mode, do not change the pulse width or range. If the pulse width is changed, the IFD routine will reset and start collecting data at the new pulse width.

The intermittent fault waveforms are stored in memory. This is an important difference between the Model 1205CXA and other TDRs. While the waveform is in memory, there are three important things to note:

1. The waveform can be adjusted as if it were a live waveform.
2. Make sure the Model 1205CXA battery is fully charged. In the IFD mode, if the instrument battery level goes below a minimum safe level, the instrument will turn itself off to prevent possible battery damage.
3. Waveforms can be stored and taken back to the office for downloading to a computer via WAVE-VIEW software or to a serial printer for archiving.

To store an IFD waveform, select Store from the pop-up menu while in the IFD mode. The instrument will save the intermittent waveform in a dedicated IFD memory location. If a waveform has been stored in the IFD memory, the next time you enter the IFD mode, a prompt

will appear to confirm you wish to overwrite the old waveform. Stored IFD waveforms have approximately maximum 1/2 distance range compared to normal stored waveform of equivalent pulse width.

2.3.5 Zoom Control

The Horizontal Zoom control expands and contracts the waveform around center screen. This control can be used to closely examine a feature found using preset RANGE operation or can be used for complete control of the waveform display distance.

2.3.6 Vertical Gain

The Vertical Gain control increases or decreases the vertical amplitude or gain of the waveform display. Increasing the vertical gain of the waveform display allows the user to see smaller reflections or minor faults on the cable signature.

2.3.7 Cable Type Menu

The Cable Type Menu is used to select the type of cable under test which sets the VOP control to the correct value. The VOP control can still be changed at any time by the operator if a different VOP value is required.

2.3.8 Setup Options Menu

Before using your Model 1205CXA, there are several setup options you can choose. The options you choose will remain selected, even when the instrument is turned off.

Options available

Horizontal Scale Units:	FEET or METERS
Distance format:	FEET, METERS, or TIME
dBRL Type:	FAULT or TOTAL
Horizontal Reference:	ON or OFF
Backlight at start-up:	ON or OFF
Velocity format:	VOP % or V/2
VOP precision:	2 DIGIT or 3 DIGIT
Cancel test lead length:	YES or NO
Serial printer type:	CITIZEN PN60 or SEIKO DPU 411
Auto Filter:	ENABLED or DISABLED

The horizontal scale units option allows the distance scale, shown on screen, to display in feet or meters.

The distance format option allows the operator to select the distance between cursors and waveform distance markers to either feet, meters, time, or combinations of these three.

The dBRL type option selects the method for dBRL calculation. "Total" displays the dBRL of the fault, plus the attenuation of the cable. "Fault" displays dBRL of the fault minus the attenuation of the cable.

The horizontal reference option allows the user to display a horizontal reference line on the center of the display.

The backlight at start-up option is used to select whether the LCD backlight is on or off at start-up.

The velocity format option selects whether the velocity of propagation control is displayed as a percentage of the speed of light (VOP) or as meters or feet per microsecond velocity divided by 2 ($V/2$). VOP precision selects the precision of the VOP display and can be either 2 or 3 digit precision.

The cancel test lead length option allows the user to automatically subtract the length associated with the test leads from the distance between cursor readout. The instrument will place the first cursor at the end of the test leads.

NOTE: If test leads are not used, make sure to disable the cancel test lead length.

The serial printer option is used to select the type of serial printer for RS232 printing. The options available are Seiko DPU 411 thermal printer and the Citizen PN60 plain paper printer.

The Auto Filter option enables or disables automatic software noise filtering. When enabled, the software noise filtering will automatically be activated if a high level of external noise is detected on the input.

2.3.9 Waveform Storage and Recall

Model 1205CXA's SUPER-STORE waveform storage capability allows the operator to store a waveform for later comparison and analysis. SUPER-STORE stores the entire cable under test, not just the section of cable displayed on screen at the time of storage. This feature is helpful if: the incorrect section of cable was on screen at the time of storage; comparing two separate waveforms (cables); or for comparing the same waveform (cable) before and after repairing the cable.

The Model 1205CXA comes standard with eight SUPER-STORE waveform memory locations. The Extended memory option is available to increase the stored waveform capacity to 32 waveforms. The waveform(s) will remain in storage, whether the instrument is on or off.

To store a waveform, scroll through the menu items until STORE is highlighted. SUPER-STORE will prompt the operator to select a memory location.

NOTE: If a memory location is selected which already has a stored waveform, the user will be prompted to overwrite the existing waveform or cancel the store. Memory locations do not have to be “cleared” to use.

The user can clear all waveforms in memory by using the “clear waveform” function.

To choose a previously stored waveform, scroll through the menu until RECALL is highlighted. A memory selection list will appear allowing the user to select the desired memory location. Choose any of the stored waveforms by scrolling to the desired number. When the desired location number is highlighted, press * to select the stored waveform to be displayed with the live waveform. All instrument functions will operate normally.

SUPER-STORE will optimize the distance and resolution of a stored waveform based on the pulse width of the test. The following table describes minimum distances versus pulse width of a stored waveform.

Pulse Width	Coax Distance (83% VOP)
Sub nsec	450ft (180m)
2 nsec	1,500ft (590m)
25 nsec	5,000ft (1,970m)
100 nsec	10,000ft (3,940m)
500 nsec	15,000ft (5,900m)

2.3.10 Noise Filter / Powered Cable

Testing a cable that has power or a signal present is possible, although for safety reasons, it is not recommended.

WARNING: The Model 1205CXA’s input is protected. The instrument features a POWERED CABLE WARNING which appears in the message center when a cable with power present is attached. However, for safety reasons, it is recommended that the Model 1205CXA **NOT** be connected to cable where a signal or power is present.

If you must test a cable with power present, the Model 1205CXA features NOISE FILTERS. If the Model 1205CXA is connected to a cable with power present, the microprocessor automatically filters out the power

signal and displays only the normal waveform of the cable under test. When the NOISE FILTER automatically engages, the message center will alternately display POWERED CABLE and AUTO FILTER.

If noise or power is present at levels not sufficient to automatically engage the noise filter, the filter can be switched on manually.

If any key is touched while the noise filter is in use, the filter is disengaged while that key function is performed. The filter reengages after five display cycles. This allows multiple keypad selections without waiting for the filter to engage or disengage.

NOTE: It takes longer to generate a waveform with the noise filter engaged. Therefore, the waveform repetition rate is reduced.

NOTE: The filter will not protect the instrument from damage caused by high voltage.

Multifunction Waveform Filtering (Optional)

This option provides a unique multilevel filtering system for filtering various types of interference. Each touch of the FILTER key engages a different type or level of filter. Try each of the filters to determine which filter works the best for each test.

TDRs are used in a variety of industries and applications. With the various types of test surroundings, also comes various types of signals which can affect the performance of a TDR.

Signals such as power (50 to 400 Hz), audio (100 Hz to 20,000 Hz), data (50 kHz to 10 MHz), and RF (500 kHz to 1 GHz) can all affect a TDR differently. Therefore, a TDR with only one type of filtering system may work well in one application but not in another.

Riser-Bond Instruments has addressed this problem by engineering a unique multifunction/multilevel noise filtering system into the Model 1205CXA which can greatly improve test results under these types of conditions.

By selecting FILTER from the menu and using either icon key, you can manually step through various levels and types of noise filters. Each touch of the ICON key starts a new type and level of filtering, each of which will be displayed in the message center. Every filter should be tried in order to determine the best result.

If power is still present on the cable after the FILTER option is deselected in the menu, the message center will alternately display POWERED CABLE and FILTER OFF.

The combination of automatic and manual noise filters effectively filters out unwanted signals and will display the normal waveform signature of the cable.

2.3.11 Charging the Batteries

The Model 1205CXA is powered by a rechargeable battery pack contained within the instrument. The Model 1205CXA is shipped from the manufacturing plant with a full charge and will operate approximately 6 hours between charges.

When the battery supply has been depleted and the batteries need to be recharged, plug the external battery charger into the front panel charger socket and into any common AC outlet. The front panel green LED will light to indicate the batteries are being charged. The LED indicator will stay illuminated while the charger is plugged in.

The Model 1205CXA will operate while being charged as long as the battery level indicator is above a quarter

charge. Allow at least 16 hours charging time for the batteries to cycle from a completely discharged state to a fully charged state. The Model 1205CXA may be operated while the batteries are charging, but this will increase the charging time.

The Model 1205CXA has a built-in, current-limiting circuit which limits battery charge current. As the batteries approach maximum charge, the charging rate is decreased. Do not leave the batteries charging for long periods of time; their useful life will be shortened. The Model 1205CXA can be charged with either an AC or DC power source with correct voltage and current specifications.

NOTE: The Model 1205CXA may also be charged using an optional 12 volt cigarette lighter adapter.

2.3.12 RS-232 Interface

Model 1205CXA includes an RS-232 Interface Connector for serial printing and the WAVE-VIEW software option. Two serial printer drivers are available in the setup options menu.

SECTION 3: TDR FUNDAMENTALS

3.1 First Time Start-up

Before using your Model 1205CXA, there are several setup options you can choose from. Select the Setup menu control and select the desired default settings for the instrument. The options you choose will remain selected, even when the instrument is turned off. (See Section 2.3.8 for setup options.)

3.2 Cable Connection

It is important to establish a quality connection to the cable under test. The TDR sends a high frequency signal that is not efficiently transmitted through poor connections or inadequate test leads.

3.3 Cable Check

Do a quick check of the cable. Get as close to the suspected fault as possible. Use common sense when examining the area near to the suspected fault. For example, if there is a new fence, that is probably where the problem is located.

When testing a section of cable where different types of cable

are spliced, use the independent cursors and the correct VOP for each section of cable to yield the most accurate reading.

3.4 Cable Impedance

Any time two metallic conductors are placed close together, they form a transmission line which has a characteristic impedance. A TDR tests for a change in impedance which can be caused by cable damage, faulty splices, water ingress, change in cable type, improper installation and even manufacturing flaws.

The insulating material that keeps the conductors separated is called the cable dielectric. The impedance of the cable is determined by the conductor diameter, the spacing of the conductors from one another, and the type of dielectric or insulation used.

3.5 Velocity of Propagation (VOP)

Determine VOP: The VOP number of a cable is determined by the dielectric material that separates the two conductors. In a coaxial cable, the foam separating the center conductor and the outer sheath is the material determining the VOP. In twisted pair, the VOP number is determined by the spacing between conductors and the insulation that separates them.

The VOP of a cable can change with temperature, age and humidity. It can also vary from one manufacturing run to another. Even new cable can vary as much as +/- 3%.

There are several ways to determine the correct VOP. The first is to simply refer to the VOP card provided with the instrument. Second, consult the manufacturer for the correct VOP of that specific cable. A third way is to actually determine the VOP from a known cable length. Measure a known cable length, the longer the cable, the more accurate the VOP will be. Correctly place the cursors of the TDR on the output pulse and the reflected pulse (end) of the cable. Change the VOP setting until the "Distance Between Cursors" displays the known length. You have now determined the VOP of the cable.

Reducing VOP error: When trying to pinpoint a fault, the most common technique used to reduce VOP error is to test the faulty cable from both ends. The procedure is as follows:

Determine the path of the cable. With a measuring wheel or tape, measure the exact length of the cable being tested. Set the VOP according to the manufacturer's specifications, test the cable from

one end and record the fault distance reading. Next, using the same VOP setting, test from the opposite end of the cable and again record the fault distance reading. If the sum of the readings is the exact length of the cable that was measured, the VOP is correct and the fault has been located.

However, if the sum of the two readings is more than the measured distance, reduce the VOP setting and retest. If the sum of the two readings is less than the measured distance, increase the VOP setting and retest, but the operator must also consider the possibility of **two** faults. Keep changing the VOP settings until the distance readings total the known length.

The same result can be obtained mathematically. Take the actual cable length and divide by the sum of the two TDR readings obtained by the tests from each end. This produces an adjustment factor. Next, multiply each of the TDR readings by the adjustment factor. The result will be the corrected length readings.

Example: TDR readings equal 700 feet and 500 feet from either end. Actual cable distance equals 1000 feet.

$$700 + 500 = 1200$$
$$1000/1200 = \text{Adjustment Factor} = 0.833$$
$$700 \times 0.833 = 584 \text{ actual (corrected length)}$$
$$500 \times 0.833 = 416 \text{ actual (corrected length)}$$

NOTE: When measuring cable reels, cable coiled on the reel can cause an error in the length reading by as much as 2 to 5%.

3.6 Pulse Widths

Many TDRs have selectable pulse width settings. The pulse width allows the TDR signal to travel down a cable at different levels of energy and distances. The wider the pulse width, the more energy is transmitted, and therefore, the further the signal will travel down the cable.

NOTE: Always start the fault finding procedure in the shortest pulse width available, as the fault may be only a short distance away. Use the range or zoom and gain controls to locate fault. If the fault is not located, adjust to the next

range or larger pulse width and retest. Keep adjusting to the next larger pulse until the fault is located.

Cable Loss

Cable has loss. A signal attenuates as it travels down a cable. Some cables have greater loss or signal attenuation than others. Because the pulse amplitude is reduced by the loss in the cable, major faults at long distances will appear to be of the same amplitude as minor faults close to the instrument.

Attenuation affects the maximum length of cable that can be tested. The greater the cable attenuation, the more energy must be sent down the cable to test longer lengths. To increase the amount of energy transmitted into the cable, increase the pulse width. The Model 1205CXA has multiple pulse widths which the operator can select to best accommodate the cable length being tested. However, since the location of a fault is unknown, it is best to start the testing procedure in the shortest pulse and increase the pulse widths as the distance being tested is increased.

3.7 Return Loss / Fault Severity

A unique feature of Model 1205CXA is AUTOMATIC dBRL calculation. This eliminates the need to visually and/or manually calculate the RETURN LOSS at a particular point on the waveform.

The RETURN LOSS (dBRL) reading is calculated using the signal **amplitudes** and **waveform data samples** taken just to the left and right of each cursor. It is best to position the cursors along the leading edge of both pulses.

Return Loss is a way of measuring impedance changes in a cable. The algorithm for determining return loss is:

$$\text{dBRL} = 20 \text{Log}_{10} V_O / V_R$$

Where V_O is the amplitude of the transmitted pulse and V_R is the amplitude of the reflected pulse.

A small value dBRL number means that most of the pulse energy is reflected by the cable fault. An open or short would reflect all the energy so its return loss is zero.

Remember, the larger the dBRL reading, the smaller the problem and vice versa.

The Model 1205CXA can be set up to display dBRL in two possible modes, Total dBRL and Fault dBRL.

Total dBRL displays the dBRL of the fault, plus the attenuation of the cable or cable loss.

Fault dBRL displays the dBRL of the fault and factors out the attenuation of the cable or cable loss.

In the Fault dBRL mode, the attenuation (loss) of the cable has been subtracted out of the display reading. Therefore, a complete open or short will read 0 dBRL, regardless of the length of cable.

NOTE: The only way to get an accurate measurement in the Fault dBRL mode is to use the Setup menu to enter the type of cable under test.

To select Fault dBRL mode, press the Menu key and select CABLE TYPE. Select Fault dBRL. After Fault dBRL is selected, you will be prompted to select the type of cable under test. This is necessary to accurately cancel out attenuation effects on the dBRL reading.

Selecting a cable type will also set the VOP of that particular cable into the VOP display settings.

SECTION 4: APPLICATION NOTES

4.1 TDR - Tap Plate Connector

It can be tiresome breaking down installed taps and installing an adapter in order to test the cable with a TDR. A solution is to modify a tap plate of the same type in your system to connect the TDR to each leg of the cable. The modified tap plate can be installed

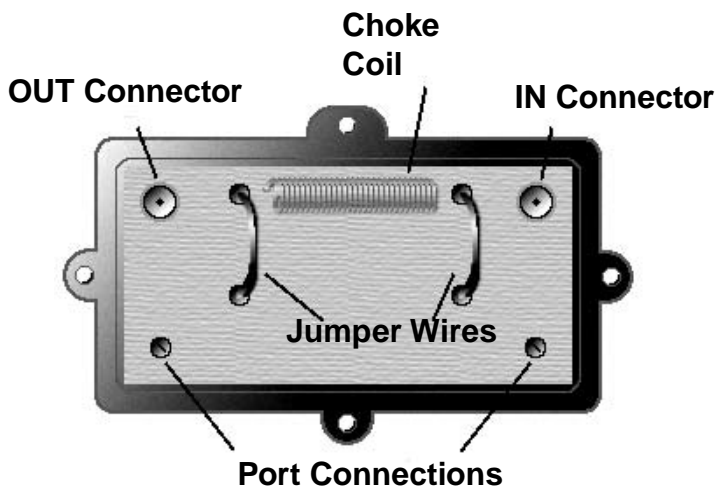

instead of the original tap plate to gain quick and easy access to the cable.

First, using a two port tap, remove the circuit board. De-solder and remove all the components, from the circuit board. Next, make two wire jumpers which connect the input and output ports to housing connectors at the respective tap ports on the plate. Connect the input connector to one tap port and the output connector to the other tap port. This makes the two tap ports independent from each other and used to test in either direction from the tap.

To find a location for the wire jumper, look for a coil connection from the IN to the OUT port which passes any power signal on the cable through the tap. Solder one end of a wire jumper to one side of the removed coil location. To connect the jumper to the tap port, look for a hole in the circuit board which is connected to the tap port center conductor. Solder the other end of the jumper here. Do this for both tap ports. Use an Ohmmeter to check for continuity when trying to locate which holes in the board to use, and to check to see if the plate is wired properly.

To use, remove an existing face plate of a tap either overhead or underground and replace it with a modified TAP plate. Connect the lead from the TDR to the

input tap port and test the cable back to the next tap. Double check that there is no AC on the line. Alternatively, connect the lead to the output tap port and read the following tap. Removing face plates is a lot easier and quicker than working with connectors.

Warning: Make sure you do not test cable with AC on the line.

4.2 Missing Signals, Corroded Splices, and Un-identified Cables

Missing Signals - In certain situations cables may go bad for no apparent reason. For example a signal may not be getting into a cable. Start by verifying the problem is not within the transmitting equipment. If the problem is not in the transmitting equipment then begin to check the cable with a TDR. Check the cable from both ends to find the fault.

After locating the fault on the waveform, measure out to the distance of the fault, then check for anything unusual. For example, a new sign driven into the ground or a new fence, look for the obvious problem. Then repair the faulty part of the cable.

Corroded Splices - Within many systems, there are a lot of cable splices. Many are old and their locations are unknown. With most splices, it is just a matter of time before they go bad. Use a TDR to locate corroded splices that need to be repaired.

Identifying Cables - If no markings were used during construction, one can go back with the aid of a plant map and use the TDR to identify cables by their length. This is a very efficient way to accurately identify and mark cables.

4.3 Detecting Intermittent Faults

As sometimes happens, a cable may cause a problem only when the wind blows, the rain falls, or infrequently for no apparent reason. When this type of problem occurs, the IFD function of the instrument can be a real time saver.

The IFD mode can be used to monitor a cable for “intermittent” type problems. The instrument will monitor the cable, waiting for the mysterious or elusive event to take place. If a change in the waveform does occur, the instrument will capture the change, not letting it disappear. With the event captured, the distance can be measured and the mystery solved.

When using the IFD mode, there should be no power present (RF or AC) that can affect the readings. The test can take only a few minutes or the instrument can be left on indefinitely to help capture even the most stubborn intermittent fault.

4.4 Measuring and Documenting

Measuring - Cable inventory and management can be very expensive and time consuming. Many companies have a problem getting technicians to use partial reels of cable, due to unknown lengths.

While learning to use the TDR, an installation crew experimented measuring reels of cable. They learned to measure and use the partial reels, which saved money and extra trips back to the warehouse.

The TDR can be used to verify the lengths of new reels of cable or to identify the lengths of unmarked reels of cable.

Documenting - Contractors can use SUPER-STORE and WAVE-VIEW to document their work or to use as proof-of-completion and/or performance. SUPER-STORE can also be used to show the need for cable replacement or repair. Documenting a cable section when newly installed makes a convenient and easy comparison when

problems arise at a later date. Cables can be periodically monitored for signs of deterioration. SUPER-STORE and WAVE-VIEW provide a variety of opportunities and applications not found with any other TDR.

SUPER-STORE Waveform Storage is a unique storage feature of Riser-Bond Instruments' waveform TDRs. SUPER-STORE waveform storage, stores all of the waveform information on screen and off screen. The user then has the ability to recall and display the waveform at any time. The waveform can still be fully adjusted. The only changes that cannot be made are in the pulse width, the impedance settings, or engaging the filters. This feature allows a more experienced person to interpret the waveform, or get a second opinion from coworkers. It also allows you to do a before and after comparisons, along with recalling information to test from both ends.

WAVE-VIEW software allows the stored waveforms to be transferred to a computer where they can be archived, adjusted, compared, or analyzed. Using WAVE-VIEW software in combination with the appropriate equipment allows the user to e-mail stored waveforms.

NOTE: Updates to WAVE-VIEW software can be downloaded from the Riser-Bond Instruments website at www.riserbond.com.

The combination of SUPER-STORE and WAVE-VIEW also make a good tool for TDR training. Students or new employees can use the computer as though it were a TDR, which keeps the TDR in the field. In addition, a variety of sample waveforms can be stored. Various cable spans and types, faults, system components and samples of known cable conditions can all be recalled and studied.

4.5 Detecting Theft of Service

A TDR is an excellent tool to determine if a device, such as a television, VCR or Converter, is connected to the end of a drop cable inside a residence. A TDR test of a cable with an open end has a very defined signature (waveform), which is easily recognizable. A waveform with an open end (upward reflection) simply indicates there are no devices connected and, most likely, no probable theft of service.

To determine theft of service, the following guidelines are recommended:

1. Once an illegal tap is located, the technician will disconnect it from service, document the time and date and possibly confiscate the coaxial cable.

2. Test and store the line connected to the house with the TDR every time you see an illegal tap. For safety reasons, it is usually necessary to test the cable and store the information as quickly as possible. Once connected, SUPER-STORE allows the technician to store the waveform in different settings in a matter of seconds. Later, the information can be recalled and adjusted as if the TDR were still connected to the cable under test. When testing into multiple unit dwellings, it is a good idea to use at least two different pulse widths: the smallest pulse width available and another to give you more distance.

3. Leave a note on the customer's door explaining what was found and how they can call to get service installed.

If the problem repeats itself, it may be necessary to inform the customer that legal action may be taken if the problem persists.

Documentation may include photographs, affidavits and any evidence found on the scene (i.e. homemade connections and waveforms from a TDR).

If a cable is illegally connected and running directly to a dwelling, that resident may still claim he/she had

no knowledge and was not using the service. Many systems have found that if they can prove that the cable is connected to a device inside the residence, they can prove it is being used.

Storing the waveform into the TDR allows the technician to gather evidence for that particular line. The waveform will show if the cable has been connected to a device or not. If it is connected to a television, VCR or cable box, it will display a lowering of impedance characteristic, or downward reflection. If the cable is not connected to a device and just lying on the ground, it will be displayed on the screen as a complete open or upward reflection.

All stored waveforms can be uploaded to WAVE-VIEW software. It provides the same flexibility as the SUPER-STORE feature. Not only can you adjust the waveform as if the TDR were still connected, you can print the results and use them as evidence.

SECTION 5: WAVEFORM EXAMPLES

A great variety of waveforms may be encountered. This is due to the various applications and electrical and environmental characteristic differences found in the wide variety of cables that exist today.

Remember: The reflection of a fault or component will look different on a short length of cable than it will on a long length of cable.

Various industries, cable types, and components produce many different waveforms. The TDR's pulse width, horizontal zoom, and vertical gain settings all affect how a waveform will appear.

Practice testing various known cable segments, with and without components. Become familiar with how each segment looks prior to any problems.

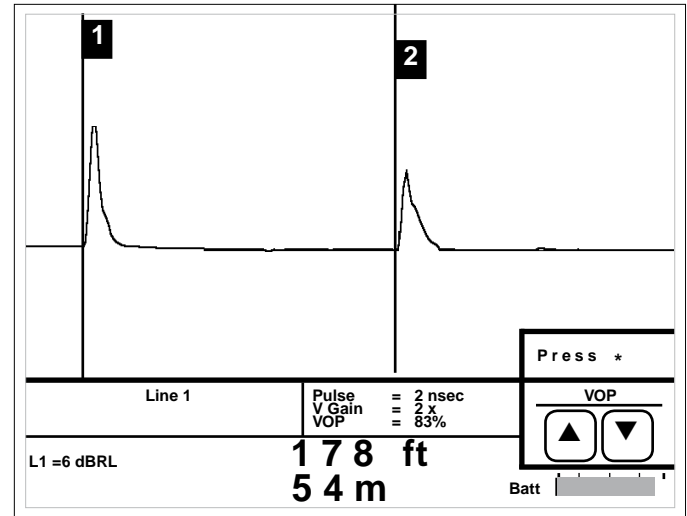

A reflection with the same polarity indicates a fault with OPEN (high impedance) tendencies. The reflection shown at the 2nd cursor is a complete open.

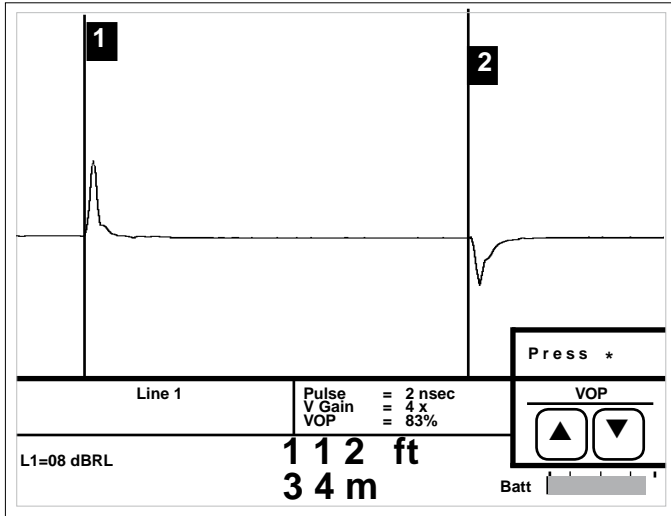

A reflection with the opposite polarity indicates a fault with short (low impedance) tendencies. The reflection shown at the 2nd cursor is a dead short.

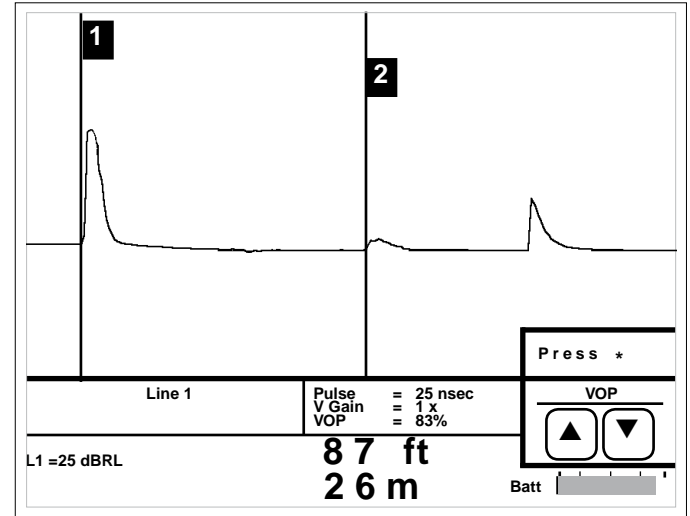

The middle reflection at the 2nd cursor is a partial open followed by a complete open (end of the cable). The more severe the fault, the larger the reflection.

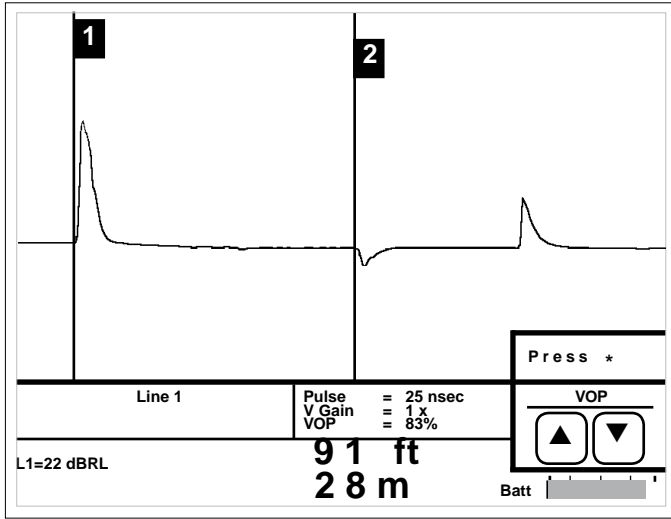

The middle reflection at the 2nd cursor is a partial short followed by a complete open (end of the cable). The more severe the fault, the larger the reflection.

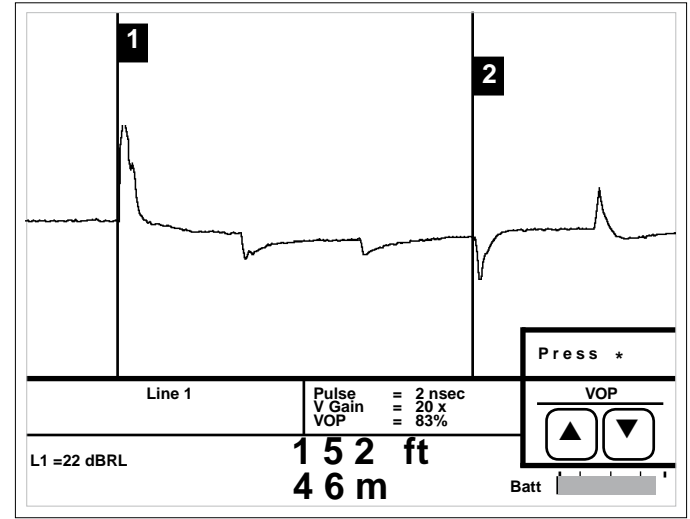

Due to attenuation, the reflections caused by each equally spaced taps are progressively smaller. A larger reflection (2nd cursor) beyond a smaller reflection may indicate an unterminated or faulty tap.

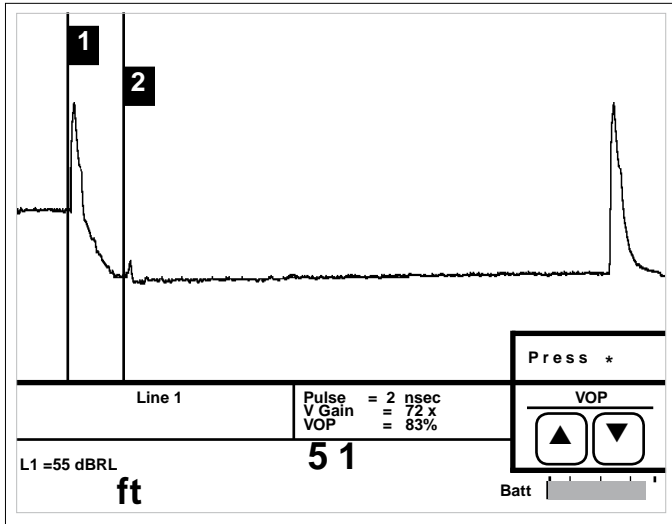

Two sections of cable with a splice shown at the 2nd cursor. The amount of reflection caused by the splice is directly proportional to the quality of the splice. A good splice = small reflection; a bad splice = large reflection.

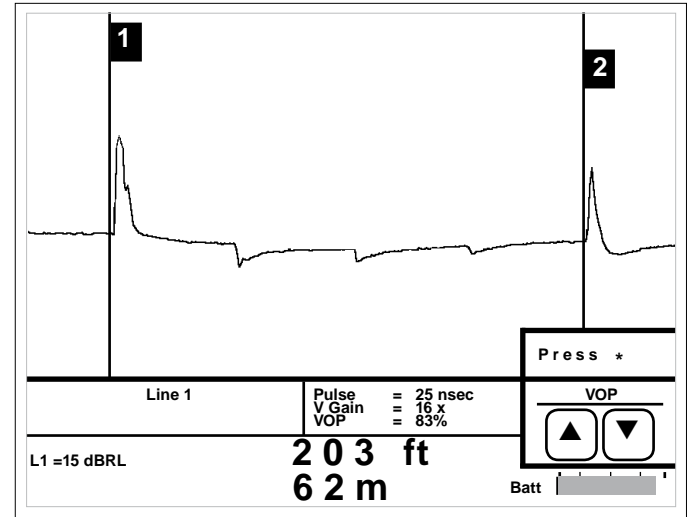

Coaxial taps (both indoor and outdoor) will cause reflections along the waveform. The quality and value of each tap determines the amount of reflection.

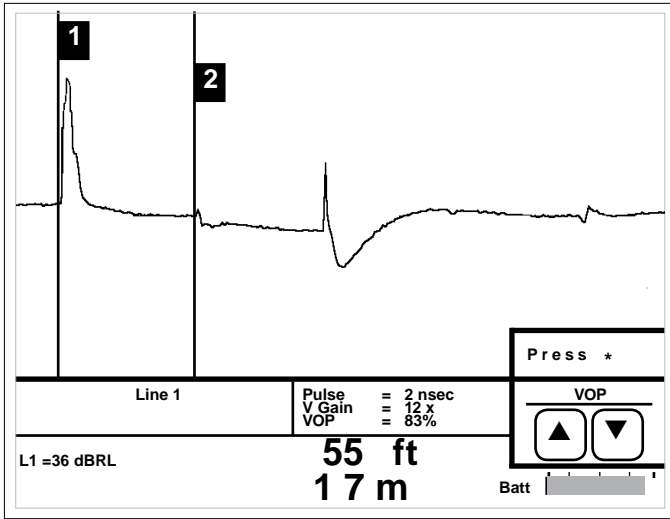

A splitter or directional coupler can be identified although accurate measurements are difficult due to multiple reflections. The 2nd cursor identifies the splitter. The two reflections following are the ends of each of the cable lengths.

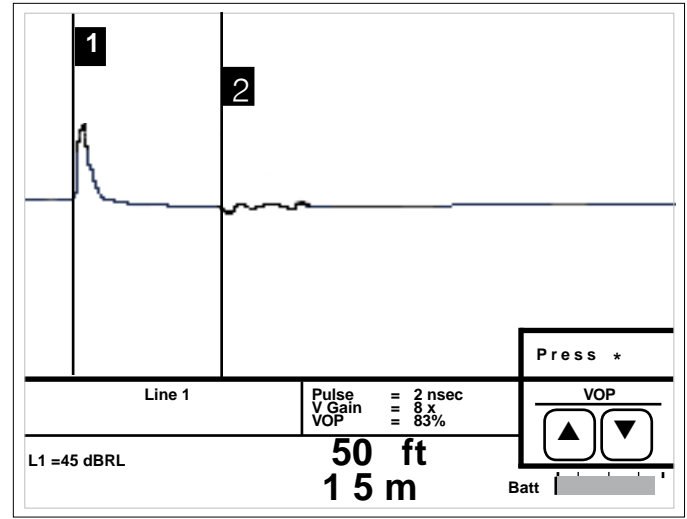

A water-soaked cable will display a waveform with a downward slope indicating the beginning of the water and an upward rise at the end of the water. Generally, the area between the two reflections will appear “noisy.”

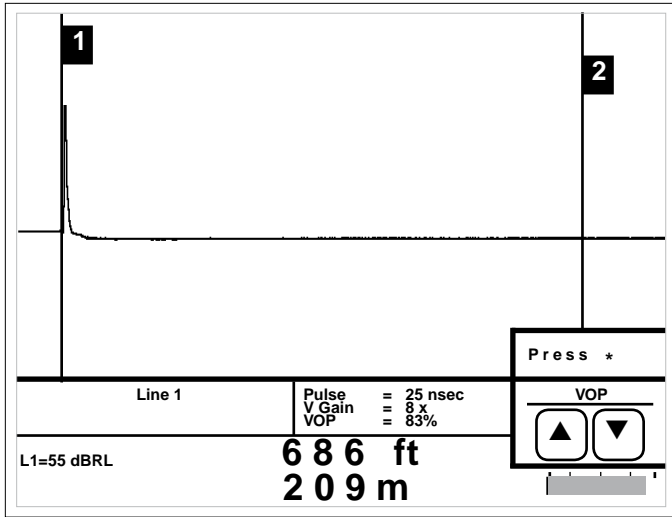

A properly TERMINATED cable will absorb the TDR signal, resulting in no reflection. Faults prior to the termination may appear as reflections along the waveform.

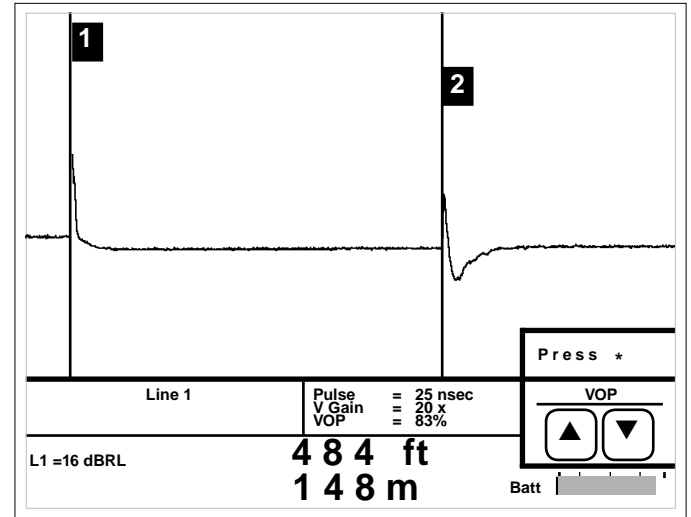

Testing through to an antenna usually results in a “S” shaped reflection, although reflections can vary greatly depending on the antenna.

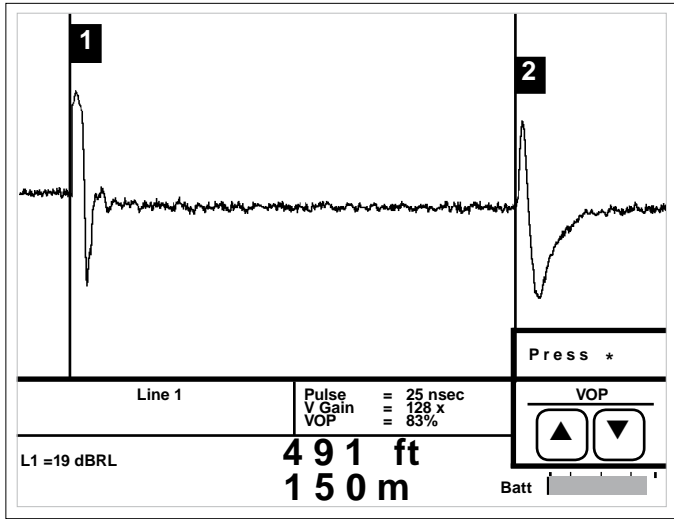

Testing tower cables with antennas can be challenging due to energy induction from high RF areas as shown in this waveform. Stepping through various noise filter settings will result in a “cleaner” waveform.

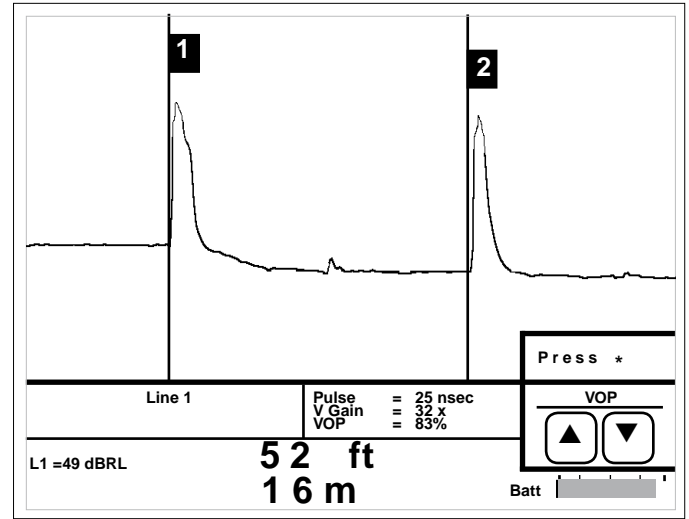

Mechanical inner-connectors (known as bullets) connecting sections of broadcast transmission line sometimes burn open causing power outages. These bullets can be detected by a TDR.

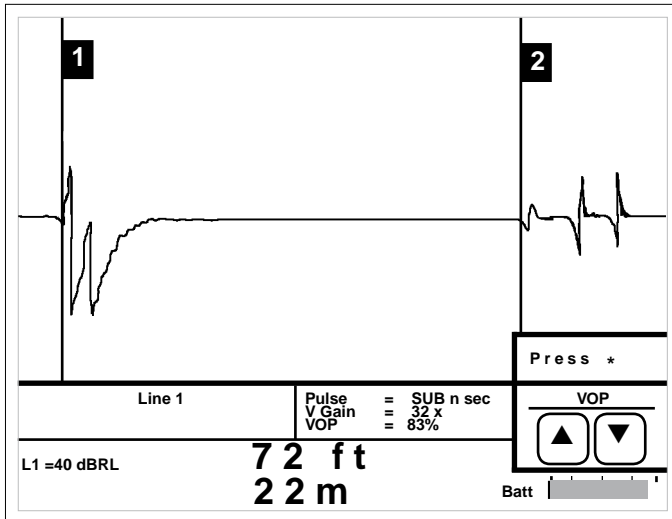

The three events seen in this section of 750 CATV hardline are a minor dent, a major dent, and a questionable splice.

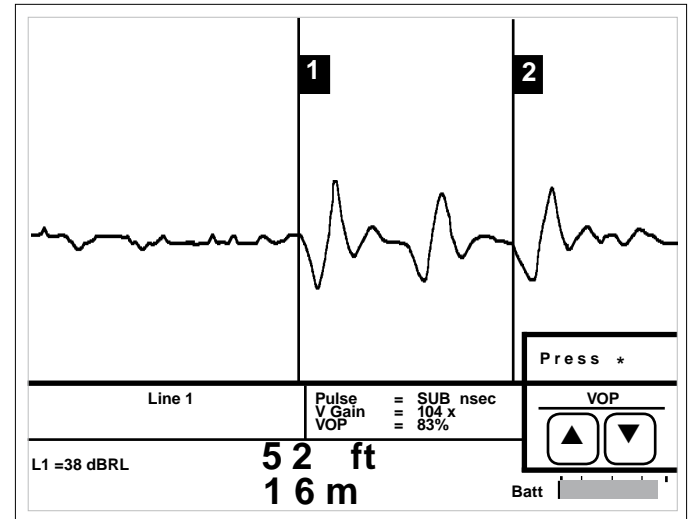

The horizontal zoom and vertical gain keys allow the operator to view these three crimps more closely.

SECTION 6: MAINTENANCE

Cleaning

Remove dust from the outside of the instrument and connectors with a lint free cloth or a small, soft brush.

Clean the case and instrument with a mild soap and water cleanser. Make sure the cloth is only **damp** to avoid getting water in the instrument.

Do not use harsh chemicals or abrasive cleaners. Damage to the front panel overlay may result.

Periodic Inspection

To maintain the TDR in peak operating condition, periodically inspect the instrument and accessories to make sure there is no damaged, worn or missing parts or deformations in the enclosure. If the unit is regularly operated in harsh, dusty or wet environments, inspect after every use.

The instrument should be inspected and cleaned periodically. Inspect the front panel connectors for dirt, broken or deformed insulation and contacts. Clean or replace as necessary.

Inspect cable accessories for damaged insulation, bent or broken clips. Replace as necessary.

Warning: To avoid risk of electric shock, do not perform service of any type to the instrument or any accessory.

Service

There are no user serviceable parts on or in this instrument. It is recommended that service of any type, to the instrument or any accessories, be referred to Riser-Bond Instruments or another authorized repair facility.

Warning: To avoid risk of electric shock, do not perform service of any type to the instrument or any accessory.

Instrument Disposal

This instrument is equipped with non-user serviceable Nickel Metal Hydride batteries. Should this instrument need to be disposed of, please consult your local regulations as to the standard disposal procedures.

SECTION 7: SPECIFICATIONS

Specifications for Model 1205CXA

Physical - Instrument Only

Height: 9.75 inches (25 cm)
Width: 10.5 inches (27 cm)
Depth: 5 inches (27 cm)
Weight: 6 pounds (2.72 kg)

Physical with nylon carry case and accessories

Height: 15 in (38 cm)
Width: 21 in (53 cm)
Depth: 6.5 in (16 cm)
Weight: 11 lb. (5.1 kg)

Environmental:

Operating Temperature: 0° C to 50° C (32° F to 122° F)
Storage Temperature: -20° C to 60° C (-4° F to 140° F)
Humidity: 95% maximum relative, non-condensing

Distance Accuracy:

+/-0.1ft (+/-0.03m) plus (+/-0.01% of reading)

Maximum Range

63,700 ft. (19,400 m) at 99% VOP
51,500 ft (16.4 km) at 80% VOP
Range varies with VOP. Maximum testable cable lengths varies with pulse width and cable type.

Display:

320 x 240 dot-matrix liquid crystal display with cathode fluorescent (CFL) backlighting.

Power:

Battery: Internal, rechargeable, 7.2V Nickel Metal Hydride
Charging Source: External 12 VAC transformer, 1.3 A
Operating Time: greater than 6 hours, continuous

without

backlight operating

Output Signal:

Sub-nanosecond, 2nsec, 25nsec, 100nsec, and 500nsec

Horizontal Resolution:

< 2,000 feet (610m):
<0.05ft. (0.03 m) at 99.9% VOP
<0.02 ft. (0.01 m) at 30.0% VOP
>2,000 feet (610m): 1 foot (0.1m) at any VOP

Vertical Resolution

14 bits with 170 dots displayed.

Vertical Sensitivity: Greater than 65dB

Waveform Storage: (6144 samples/waveform)

Standard: 8 SUPER-STORE waveforms
Optional: 32 SUPER-STORE waveforms

Software Noise Filters:

Standard: 8x Averaging, 50/60 Hz, and Auto-Filter

Optional: 4x, 16x, 32x, 64x, 128x Averaging

Input Protection:

400V (AC+DC) from DC to 400 Hz, decreasing to 10V at 1MHz.

Velocity of Propagation: Two user-selectable display formats

VOP (%) with 3 digit precision ranging from 30.0% to 99.9%

V/2 with 4 digit precision (feet or meters per microsecond) ranging from 45.0 to 148.0 in meters mode or from 148.0 to 487.0 in feet mode

Standard Accessories:

Operator's manual, battery charger, accessory bag, shoulder strap, BNC/F adapter, WAVE-VIEW Software disks, RS-232 cable, RG-59 push-on probe, COAX VOP card

Optional Accessories:

Extended waveform storage, extended noise filters, strand hooks, softside carrying case, 12V cigarette lighter charger, extended warranty.

APPENDIX A Serial I/O Printer Port Connection

Epson LQ-860 Emulation
Model 1205CXA can interface to an Epson LQ-860 type printer through the Epson LQ-860 command set. Serial communication parameters: no parity, two-stop bits, and 9,600 baud.

Citizen PN60 Pocket Printer
Model 1205CXA interfaces to the Citizen PN60 Pocket Printer through the Epson LQ-860 command set. The printer setup parameters are as follows:

Language:	English
Font:	Roman
Font Lock:	Off
Line Spacing:	6 LPI
Character Set:	Italics
Code Page:	USA
Space Skip:	Enable
Stylewriter:	Auto
Protocol:	DTR
Emulation:	Epson
Pitch:	10 CPI
Compress:	Off
Form Length:	11 letters
Slash Zero:	On
Internal Char Set:	USA
Auto LF:	Off
Power Off:	3 minutes
Baud Rate:	9,600

APPENDIX B VOP Table

CATV

<u>CABLE</u>	<u>VOP</u>	<u>CABLE</u>	<u>VOP</u>
Belden		Scientific Atlanta	
RG-59 Foam	.78	RG-59	.81
Solid	.66	Trunk	.87
Capscan		Times Fiber	
RG-59	.82	RG-59	.83
CC	.88	T 4, 6, & 10	.87
		TR+	.87
Commscope		TX,TX10	.89
Trunk/Dist PIII	.87	RG-6, 11, & 59	.82
QR	.88	Dynafoam	.90
Drop PIII	.82		
QR	.88	Trunk / Feeder	.83
		Drop (foam 59, 6,& 11)	.82
CZ Labs		7 Series	.93
RG-59	.82	MC2	.93
General Cable			
RG-59	.82		
MC2	.93		

INDEX

A

Accessories 37
Application notes 22

B

Backlight 6
Battery charger 17
Battery Level Indicator 8

C

Cable check 18
Cable connection 18
Charging 17
Cursors 11

D

Display 7
Display modes 12
Distance markers 8

F

Features 3
Filters 9
Front panel 5

H

Horizontal zoom 11

I

Impedance 19
Instrument disposal 35

K

Keypad 6

L

Liquid crystal display 7

M

Maintenance 35
Menu 9, 10

O

Operation 10
Operation Theory 4

P

Pulse Width 20
Printer 38

R

Range 10
Recall 15
RS-232 18

S

Service 35
Set-up options 14
Start-up 18
Storage 15
Specifications 36

V

Velocity of propagation 19
Vertical gain 14

W

Warnings 2
Waveform examples 27

Z

Zoom Controls 14

WARRANTY

Riser-Bond Instruments warrants the Model 1205CXA for a period of ONE YEAR from the date of shipment from Riser-Bond Instruments' factory or its designated distributor, that the Time Domain Reflectometer Model 1205CXA shall be free from defects in material and workmanship that develop under normal use in accordance with Riser-Bond Instruments operating instructions.

Items returned for repair or replacement shall be shipped with a copy of the dated invoice, freight charges prepaid, to:

RADIODETECTION
154 PORTLAND ROAD
BRIDGTON
ME 04009
USA

TEL: (207) 647-9495
TOLL FREE: (877) 247-3797
FAX: (207) 647-9496
E-MAIL: BRIDGTON@RADIODETECTION.SPX.COM

This warranty will be void if products manufactured by Riser-Bond Instruments are modified by the purchaser during the period of warranty without Riser-Bond Instruments written consent. This warranty is expressly made in lieu of all other warranties expressed or implied, including merchantability, whether arising by law, custom or conduct. The rights or remedies provided herein are exclusive in lieu of any other rights or remedies unless specifically stated in the purchase order for this equipment. This warranty covers repair or replacement of the purchased item only and does not cover any subsidiary damages to associated customer equipment. If the extended warranty is purchased, it does not apply to the battery pack.



Radiodetection

Riser Bond

Radiodetection
154 Portland Road
Bridgton
ME 04009
USA

Tel: (207) 647-9495
Toll Free: (877) 247-3797
Fax: (207) 647-9496
E-mail: bridgton@radiodetection.spx.com

Radiodetection Ltd.
Western Drive
Bristol
BS14 0AF
United Kingdom

Tel: +44 (0) 117 976 7776
Fax: +44 (0) 117 976 7775
E-mail: sales.uk@radiodetection.spx.com